



**HYA**

PRODUCT CATALOG 2026



NEW FOR 2026

TAKE CONTROL with the

**NYTRX<sup>®</sup> XV<sup>3</sup>**

We're proud to unveil our most innovative sight system yet. After receiving countless requests for a micro-adjustable vertical 3-pin, we've listened and delivered. The XV3 combines state-of-the-art technology with exceptional American craftsmanship, setting a new standard in precision and performance. Set your pins where YOU want them.





# INTRODUCING THE

## OUR MOST ADVANCED SIGHT SYSTEM YET.

Built with direct feedback from our customers, these sights redefine customization and efficiency, giving you complete control over your set up. Want to shoot a 2 pin for whitetails but a 3 pin for elk? You no longer need two sights, the NYTRX® is your answer. Easily swap between, indicators, scopes, and frames to customize your set up.



Water Resistant  
Tapes

Interchangeable  
indicators allowing  
you to swap  
between 1, 2, 3 & 4  
indicators

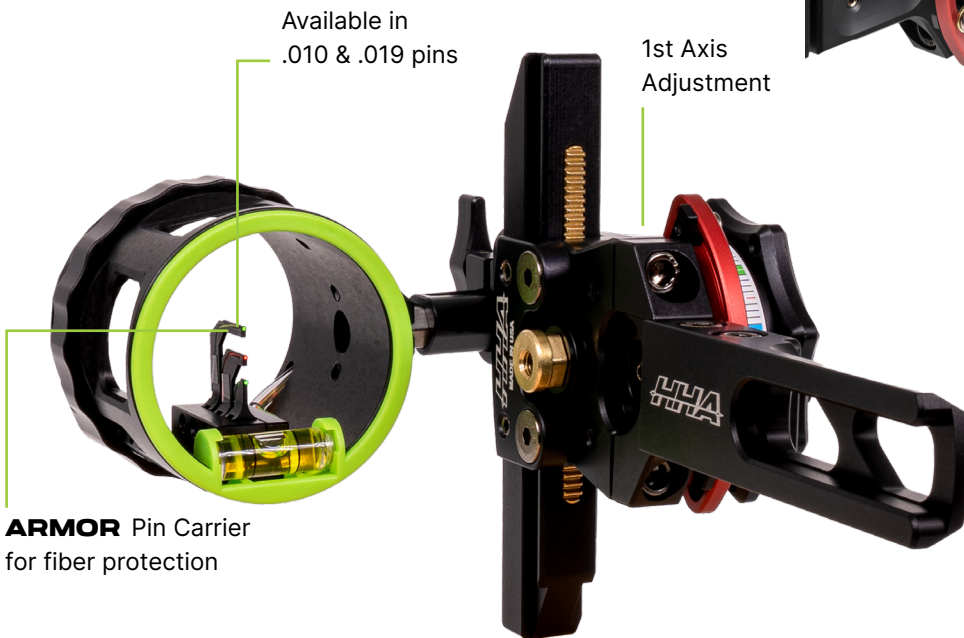

Available in  
.010 & .019 pins

1st Axis  
Adjustment

**ARMOR** Pin Carrier  
for fiber protection



Mechanical rheostat for  
fiber optic brightness  
control

## NYTRX FEATURES

- Repositioned gear rack for extended range
- Two-Stage: Macro and Micro Windage Adjustments
- **RDS** (Range, Dial, Shoot): To-the-yard accuracy with a quick turn of the wheel
- 1<sup>st</sup>, 2<sup>nd</sup>, & 3<sup>rd</sup> Axis Adjustment

# NYTRX®

AVAILABLE IN 4 SCOPE AND  
4 FRAME OPTIONS



Side Mount



Pic Mount



NEW



Bridge-Lock



Universal Dovetail  
Design Compatible  
with Bridge-Lock™



X<sup>1</sup>  
1 Pin Vertical



X<sup>2</sup>  
2 Pin Vertical

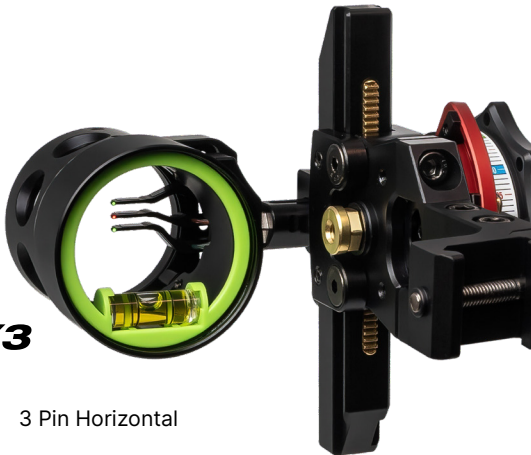

X<sup>3</sup>  
3 Pin Horizontal



NEW

XV<sup>3</sup>  
3 Pin Vertical

# INTRODUCING THE

## THE BEST SIGHT WE HAVE EVER BUILT.

All the features of the NYTRX®, plus the ability to swap between yardage wheels to shoot multiple arrow setups and for ease of swapping between tapes. Looking to swap between scopes and indicators? The NYTRX PRO is the only way to go. Each NYTRX PRO comes with two yardage wheels, to seamlessly swap between your set ups.

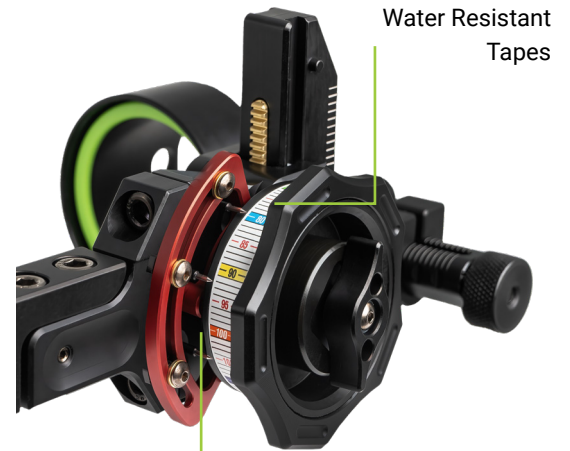

Water Resistant Tapes

Interchangeable indicators allowing you to swap between 1, 2, 3 & 4 indicators

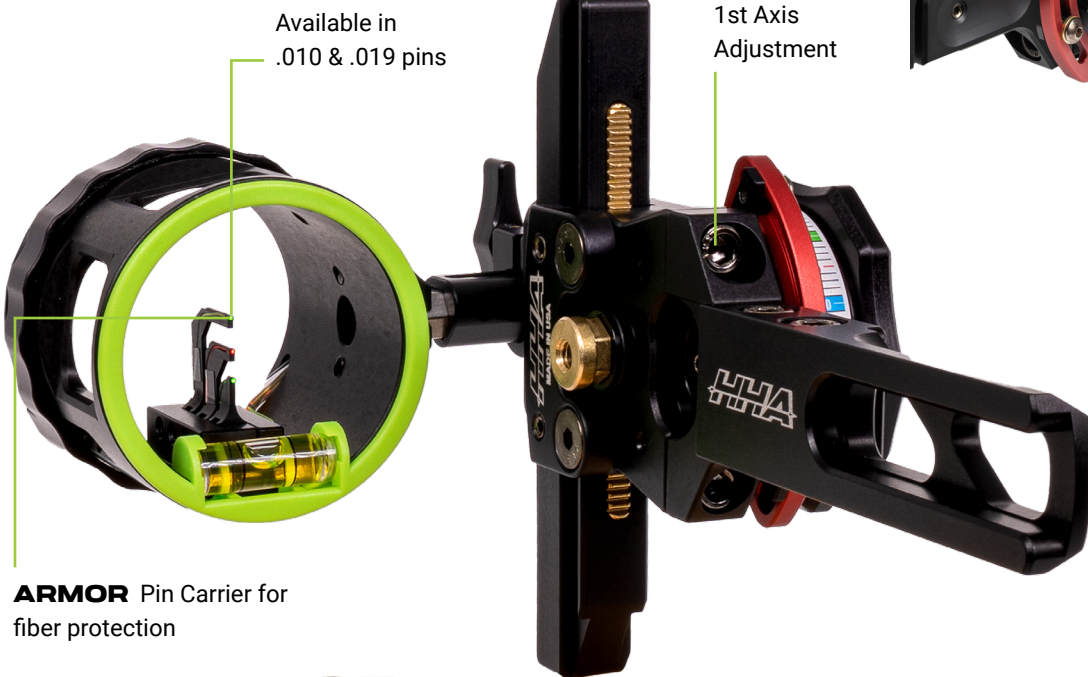

Available in .010 & .019 pins

1st Axis Adjustment

**ARMOR** Pin Carrier for fiber protection

Mechanical rheostat for fiber optic brightness control



## NYTRX PRO FEATURES

- Repositioned gear rack for extended range
- Two-Stage: Macro and Micro Windage Adjustments
- **RDS** (Range, Dial, Shoot): To-the-yard accuracy with a quick turn of the wheel
- Now featuring the longest sight tape sets we have ever built
- New Yardage Wheel for fast adjustments
- Two Wheels to swap between setups

# NYTRX<sup>®</sup>

AVAILABLE IN 4 SCOPE AND  
4 FRAME OPTIONS

# PRO



Side Mount



Pic Mount



NEW



Bridge-Lock



Universal Dovetail  
Design Compatible  
with Bridge-Lock™

X<sup>1</sup>  
1 Pin Vertical



X<sup>2</sup>  
2 Pin Vertical

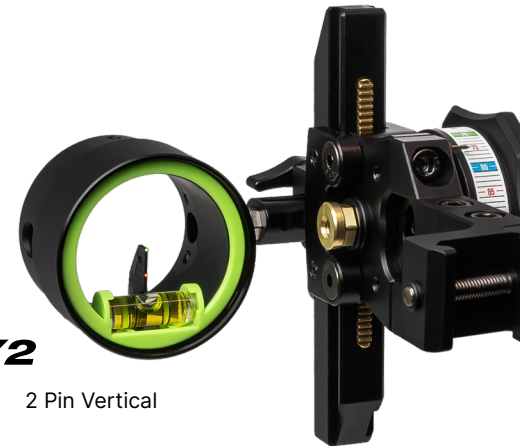

X<sup>3</sup>  
3 Pin Horizontal

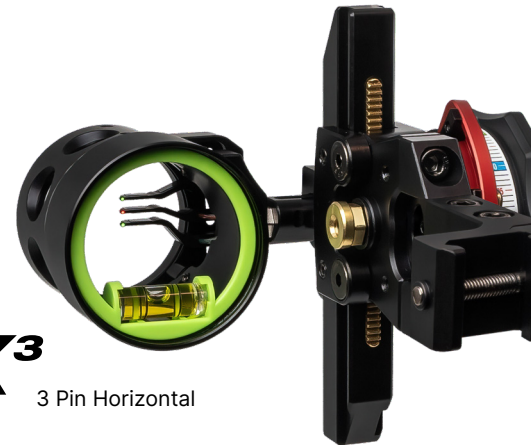

NEW  
XV<sup>3</sup>

3 Pin Vertical



# NYTRX<sup>®</sup> PRO CUSTOM

## **MATCH YOUR SETUP. ELEVATE YOUR IDENTITY.**

Back by popular demand, the NYTRX PRO is again offered in Cerakote. Our top selling colors return, Moss and Slate, along with new colors to match popular bow manufacturers on the market like Hoyt, Mathews, PSE, and Prime.

**AVAILABLE SIGHT OPTIONS:** X2, X3, XV3

**BRIDGELOCK OPTIONS:** Bottomland, Slate, Desert Sand, Grizzly Brown, Moss

**PIC MOUNT OPTIONS:** Graveyard, Moss, Bottomland





**SLATE**

**GRAVEYARD**



**MOSS**

**DESERT SAND**



**BOTTOMLAND**

**GRIZZLY BROWN**

# NYTRX<sup>®</sup> PRO X<sup>1</sup>



Part #	Removable Wheel	Pin Size	# of Pins	Sight Housing	Lens Kit (Optional)	Sight Light (Optional)
BL-NPRO-X119	Yes	.019	1	1 5/8"	Yes	Yes
BL-NPRO-X119 LH	Yes	.019	1	1 5/8"	Yes	Yes
BL-NPRO-X110	Yes	.010	1	1 5/8"	Yes	Yes
BL-NPRO-X110 LH	Yes	.010	1	1 5/8"	Yes	Yes



Part #	Removable Wheel	Pin Size	# of Pins	Sight Housing	Lens Kit (Optional)	Sight Light (Optional)
NPRO-X119	Yes	.019	1	1 5/8"	Yes	Yes
NPRO-X119 LH	Yes	.019	1	1 5/8"	Yes	Yes
NPRO-X110	Yes	.010	1	1 5/8"	Yes	Yes
NPRO-X110 LH	Yes	.010	1	1 5/8"	Yes	Yes



Part #	Removable Wheel	Pin Size	# of Pins	Sight Housing	Lens Kit (Optional)	Sight Light (Optional)
HYT-NPRO-X119	Yes	.019	1	1 5/8"	Yes	Yes
HYT-NPRO-X119 LH	Yes	.019	1	1 5/8"	Yes	Yes
HYT-NPRO-X110	Yes	.010	1	1 5/8"	Yes	Yes
HYT-NPRO-X110 LH	Yes	.010	1	1 5/8"	Yes	Yes



Part #	Removable Wheel	Pin Size	# of Pins	Sight Housing	Lens Kit (Optional)	Sight Light (Optional)
SB-NPRO-X119	Yes	.019	1	1 5/8"	Yes	Yes
SB-NPRO-X119 LH	Yes	.019	1	1 5/8"	Yes	Yes
SB-NPRO-X110	Yes	.010	1	1 5/8"	Yes	Yes
SB-NPRO-X110 LH	Yes	.010	1	1 5/8"	Yes	Yes

# NYTRX<sup>®</sup> PRO X<sup>2</sup>

Part #	Removable Wheel	Pin Size	# of Pins	Pin Color	Sight Housing	Lens Kit (Optional)	Sight Light (Optional)
BL-NPRO-X219-GR	Yes	.019	2	Green & Red	1 5/8"	Yes	Yes
BL-NPRO-X219-GR LH	Yes	.019	2	Green & Red	1 5/8"	Yes	Yes
BL-NPRO-X219-GY	Yes	.019	2	Green & Yellow	1 5/8"	Yes	Yes
BL-NPRO-X219-GY LH	Yes	.019	2	Green & Yellow	1 5/8"	Yes	Yes
BL-NPRO-X210-GR	Yes	.010	2	Green & Red	1 5/8"	Yes	Yes
BL-NPRO-X210-GR LH	Yes	.010	2	Green & Red	1 5/8"	Yes	Yes
BL-NPRO-X210-GY	Yes	.010	2	Green & Yellow	1 5/8"	Yes	Yes
BL-NPRO-X210-GY LH	Yes	.010	2	Green & Yellow	1 5/8"	Yes	Yes



Part #	Removable Wheel	Pin Size	# of Pins	Pin Color	Sight Housing	Lens Kit (Optional)	Sight Light (Optional)
NPRO-X219-GR	Yes	.019	2	Green & Red	1 5/8"	Yes	Yes
NPRO-X219-GR LH	Yes	.019	2	Green & Red	1 5/8"	Yes	Yes
NPRO-X219-GY	Yes	.019	2	Green & Yellow	1 5/8"	Yes	Yes
NPRO-X219-GY LH	Yes	.019	2	Green & Yellow	1 5/8"	Yes	Yes
NPRO-X210-GR	Yes	.010	2	Green & Red	1 5/8"	Yes	Yes
NPRO-X210-GR LH	Yes	.010	2	Green & Red	1 5/8"	Yes	Yes
NPRO-X210-GY	Yes	.010	2	Green & Yellow	1 5/8"	Yes	Yes
NPRO-X210-GY LH	Yes	.010	2	Green & Yellow	1 5/8"	Yes	Yes



Part #	Removable Wheel	Pin Size	# of Pins	Pin Color	Sight Housing	Lens Kit (Optional)	Sight Light (Optional)
HYT-NPRO-X219-GR	Yes	.019	2	Green & Red	1 5/8"	Yes	Yes
HYT-NPRO-X219-GR LH	Yes	.019	2	Green & Red	1 5/8"	Yes	Yes
HYT-NPRO-X219-GY	Yes	.019	2	Green & Yellow	1 5/8"	Yes	Yes
HYT-NPRO-X219-GY LH	Yes	.019	2	Green & Yellow	1 5/8"	Yes	Yes
HYT-NPRO-X210-GR	Yes	.010	2	Green & Red	1 5/8"	Yes	Yes
HYT-NPRO-X210-GR LH	Yes	.010	2	Green & Red	1 5/8"	Yes	Yes
HYT-NPRO-X210-GY	Yes	.010	2	Green & Yellow	1 5/8"	Yes	Yes
HYT-NPRO-X210-GY LH	Yes	.010	2	Green & Yellow	1 5/8"	Yes	Yes



Part #	Removable Wheel	Pin Size	# of Pins	Pin Color	Sight Housing	Lens Kit (Optional)	Sight Light (Optional)
SB-NPRO-X219-GR	Yes	.019	2	Green & Red	1 5/8"	Yes	Yes
SB-NPRO-X219-GR LH	Yes	.019	2	Green & Red	1 5/8"	Yes	Yes
SB-NPRO-X219-GY	Yes	.019	2	Green & Yellow	1 5/8"	Yes	Yes
SB-NPRO-X219-GY LH	Yes	.019	2	Green & Yellow	1 5/8"	Yes	Yes
SB-NPRO-X210-GR	Yes	.010	2	Green & Red	1 5/8"	Yes	Yes
SB-NPRO-X210-GR LH	Yes	.010	2	Green & Red	1 5/8"	Yes	Yes
SB-NPRO-X210-GY	Yes	.010	2	Green & Yellow	1 5/8"	Yes	Yes
SB-NPRO-X210-GY LH	Yes	.010	2	Green & Yellow	1 5/8"	Yes	Yes



# NYTRX<sup>®</sup> PRO X<sup>3</sup>



Part #	Removable Wheel	Pin Size	# of Pins	Sight Housing	Lens Kit (Optional)	Sight Light (Optional)
BL-NPRO-X319	Yes	.019	3	1 5/8"	Yes	Yes
BL-NPRO-X319 LH	Yes	.019	3	1 5/8"	Yes	Yes
BL-NPRO-X310	Yes	.010	3	1 5/8"	Yes	Yes
BL-NPRO-X310 LH	Yes	.010	3	1 5/8"	Yes	Yes



Part #	Removable Wheel	Pin Size	# of Pins	Sight Housing	Lens Kit (Optional)	Sight Light (Optional)
NPRO-X319	Yes	.019	3	1 5/8"	Yes	Yes
NPRO-X319 LH	Yes	.019	3	1 5/8"	Yes	Yes
NPRO-X310	Yes	.010	3	1 5/8"	Yes	Yes
NPRO-X310 LH	Yes	.010	3	1 5/8"	Yes	Yes



Part #	Removable Wheel	Pin Size	# of Pins	Sight Housing	Lens Kit (Optional)	Sight Light (Optional)
HYT-NPRO-X319	Yes	.019	3	1 5/8"	Yes	Yes
HYT-NPRO-X319 LH	Yes	.019	3	1 5/8"	Yes	Yes
HYT-NPRO-X310	Yes	.010	3	1 5/8"	Yes	Yes
HYT-NPRO-X310 LH	Yes	.010	3	1 5/8"	Yes	Yes



Part #	Removable Wheel	Pin Size	# of Pins	Sight Housing	Lens Kit (Optional)	Sight Light (Optional)
SB-NPRO-X319	Yes	.019	3	1 5/8"	Yes	Yes
SB-NPRO-X319 LH	Yes	.019	3	1 5/8"	Yes	Yes
SB-NPRO-X310	Yes	.010	3	1 5/8"	Yes	Yes
SB-NPRO-X310 LH	Yes	.010	3	1 5/8"	Yes	Yes

# NYTRX<sup>®</sup> PRO XV<sup>3</sup>

Part #	Removable Wheel	Pin Size	# of Pins	Sight Housing	Lens Kit (Optional)	Sight Light (Optional)
BL-NPRO-XV319	Yes	.019	3	1 3/4"	No	Yes
BL-NPRO-XV319 LH	Yes	.019	3	1 3/4"	No	Yes
BL-NPRO-XV310	Yes	.010	3	1 3/4"	No	Yes
BL-NPRO-XV310 LH	Yes	.010	3	1 3/4"	No	Yes

Part #	Removable Wheel	Pin Size	# of Pins	Sight Housing	Lens Kit (Optional)	Sight Light (Optional)
NPRO-XV319	Yes	.019	3	1 3/4"	No	Yes
NPRO-XV319 LH	Yes	.019	3	1 3/4"	No	Yes
NPRO-XV310	Yes	.010	3	1 3/4"	No	Yes
NPRO-XV310 LH	Yes	.010	3	1 3/4"	No	Yes

Part #	Removable Wheel	Pin Size	# of Pins	Sight Housing	Lens Kit (Optional)	Sight Light (Optional)
HYT-NPRO-XV319	Yes	.019	3	1 3/4"	No	Yes
HYT-NPRO-XV319 LH	Yes	.019	3	1 3/4"	No	Yes
HYT-NPRO-XV310	Yes	.010	3	1 3/4"	No	Yes
HYT-NPRO-XV310 LH	Yes	.010	3	1 3/4"	No	Yes

Part #	Removable Wheel	Pin Size	# of Pins	Sight Housing	Lens Kit (Optional)	Sight Light (Optional)
SB-NPRO-XV319	Yes	.019	3	1 3/4"	No	Yes
SB-NPRO-XV319 LH	Yes	.019	3	1 3/4"	No	Yes
SB-NPRO-XV310	Yes	.010	3	1 3/4"	No	Yes
SB-NPRO-XV310 LH	Yes	.010	3	1 3/4"	No	Yes



# NYTRX<sup>®</sup> X<sup>1</sup>



Part #	Removable Wheel	Pin Size	# of Pins	Sight Housing	Lens Kit (Optional)	Sight Light (Optional)
BL-NX-X119	No	.019	1	1 5/8"	Yes	Yes
BL-NX-X119 LH	No	.019	1	1 5/8"	Yes	Yes
BL-NX-X110	No	.010	1	1 5/8"	Yes	Yes
BL-NX-X110 LH	No	.010	1	1 5/8"	Yes	Yes



Part #	Removable Wheel	Pin Size	# of Pins	Sight Housing	Lens Kit (Optional)	Sight Light (Optional)
NX-X119	No	.019	1	1 5/8"	Yes	Yes
NX-X119 LH	No	.019	1	1 5/8"	Yes	Yes
NX-X110	No	.010	1	1 5/8"	Yes	Yes
NX-X110 LH	No	.010	1	1 5/8"	Yes	Yes



Part #	Removable Wheel	Pin Size	# of Pins	Sight Housing	Lens Kit (Optional)	Sight Light (Optional)
HYT-NX-X119	No	.019	1	1 5/8"	Yes	Yes
HYT-NX-X119 LH	No	.019	1	1 5/8"	Yes	Yes
HYT-NX-X110	No	.010	1	1 5/8"	Yes	Yes
HYT-NX-X110 LH	No	.010	1	1 5/8"	Yes	Yes



Part #	Removable Wheel	Pin Size	# of Pins	Sight Housing	Lens Kit (Optional)	Sight Light (Optional)
SB-NX-X119	No	.019	1	1 5/8"	Yes	Yes
SB-NX-X119 LH	No	.019	1	1 5/8"	Yes	Yes
SB-NX-X110	No	.010	1	1 5/8"	Yes	Yes
SB-NX-X110 LH	No	.010	1	1 5/8"	Yes	Yes

# NYTRX<sup>®</sup> X<sup>2</sup>

Part #	Removable Wheel	Pin Size	# of Pins	Pin Color	Sight Housing	Lens Kit (Optional)	Sight Light (Optional)
BL-NX-X219-GR	No	.019	2	Green & Red	1 5/8"	Yes	Yes
BL-NX-X219-GR LH	No	.019	2	Green & Red	1 5/8"	Yes	Yes
BL-NX-X219-GY	No	.019	2	Green & Yellow	1 5/8"	Yes	Yes
BL-NX-X219-GY LH	No	.019	2	Green & Yellow	1 5/8"	Yes	Yes
BL-NX-X210-GR	No	.010	2	Green & Red	1 5/8"	Yes	Yes
BL-NX-X210-GR LH	No	.010	2	Green & Red	1 5/8"	Yes	Yes
BL-NX-X210-GY	No	.010	2	Green & Yellow	1 5/8"	Yes	Yes
BL-NX-X210-GY LH	No	.010	2	Green & Yellow	1 5/8"	Yes	Yes



Part #	Removable Wheel	Pin Size	# of Pins	Pin Color	Sight Housing	Lens Kit (Optional)	Sight Light (Optional)
NX-X219-GR	No	.019	2	Green & Red	1 5/8"	Yes	Yes
NX-X219-GR LH	No	.019	2	Green & Red	1 5/8"	Yes	Yes
NX-X219-GY	No	.019	2	Green & Yellow	1 5/8"	Yes	Yes
NX-X219-GY LH	No	.019	2	Green & Yellow	1 5/8"	Yes	Yes
NX-X210-GR	No	.010	2	Green & Red	1 5/8"	Yes	Yes
NX-X210-GR LH	No	.010	2	Green & Red	1 5/8"	Yes	Yes
NX-X210-GY	No	.010	2	Green & Yellow	1 5/8"	Yes	Yes
NX-X210-GY LH	No	.010	2	Green & Yellow	1 5/8"	Yes	Yes



Part #	Removable Wheel	Pin Size	# of Pins	Pin Color	Sight Housing	Lens Kit (Optional)	Sight Light (Optional)
HYT-NX-X219-GR	No	.019	2	Green & Red	1 5/8"	Yes	Yes
HYT-NX-X219-GR LH	No	.019	2	Green & Red	1 5/8"	Yes	Yes
HYT-NX-X219-GY	No	.019	2	Green & Yellow	1 5/8"	Yes	Yes
HYT-NX-X219-GY LH	No	.019	2	Green & Yellow	1 5/8"	Yes	Yes
HYT-NX-X210-GR	No	.010	2	Green & Red	1 5/8"	Yes	Yes
HYT-NX-X210-GR LH	No	.010	2	Green & Red	1 5/8"	Yes	Yes
HYT-NX-X210-GY	No	.010	2	Green & Yellow	1 5/8"	Yes	Yes
HYT-NX-X210-GY LH	No	.010	2	Green & Yellow	1 5/8"	Yes	Yes



Part #	Removable Wheel	Pin Size	# of Pins	Pin Color	Sight Housing	Lens Kit (Optional)	Sight Light (Optional)
SB-NX-X219-GR	No	.019	2	Green & Red	1 5/8"	Yes	Yes
SB-NX-X219-GR LH	No	.019	2	Green & Red	1 5/8"	Yes	Yes
SB-NX-X219-GY	No	.019	2	Green & Yellow	1 5/8"	Yes	Yes
SB-NX-X219-GY LH	No	.019	2	Green & Yellow	1 5/8"	Yes	Yes
SB-NX-X210-GR	No	.010	2	Green & Red	1 5/8"	Yes	Yes
SB-NX-X210-GR LH	No	.010	2	Green & Red	1 5/8"	Yes	Yes
SB-NX-X210-GY	No	.010	2	Green & Yellow	1 5/8"	Yes	Yes
SB-NX-X210-GY LH	No	.010	2	Green & Yellow	1 5/8"	Yes	Yes



# NYTRX<sup>®</sup> X<sup>3</sup>



Part #	Removable Wheel	Pin Size	# of Pins	Sight Housing	Lens Kit (Optional)	Sight Light (Optional)
BL-NX-X319	No	.019	3	1 5/8"	Yes	Yes
BL-NX-X319 LH	No	.019	3	1 5/8"	Yes	Yes
BL-NX-X310	No	.010	3	1 5/8"	Yes	Yes
BL-NX-X310 LH	No	.010	3	1 5/8"	Yes	Yes



Part #	Removable Wheel	Pin Size	# of Pins	Sight Housing	Lens Kit (Optional)	Sight Light (Optional)
NX-X319	No	.019	3	1 5/8"	Yes	Yes
NX-X319 LH	No	.019	3	1 5/8"	Yes	Yes
NX-X310	No	.010	3	1 5/8"	Yes	Yes
NX-X310 LH	No	.010	3	1 5/8"	Yes	Yes



Part #	Removable Wheel	Pin Size	# of Pins	Sight Housing	Lens Kit (Optional)	Sight Light (Optional)
HYT-NX-X319	No	.019	3	1 5/8"	Yes	Yes
HYT-NX-X319 LH	No	.019	3	1 5/8"	Yes	Yes
HYT-NX-X310	No	.010	3	1 5/8"	Yes	Yes
HYT-NX-X310 LH	No	.010	3	1 5/8"	Yes	Yes



Part #	Removable Wheel	Pin Size	# of Pins	Sight Housing	Lens Kit (Optional)	Sight Light (Optional)
SB-NX-X319	Yes	.019	3	1 5/8"	Yes	Yes
SB-NX-X319 LH	Yes	.019	3	1 5/8"	Yes	Yes
SB-NX-X310	Yes	.010	3	1 5/8"	Yes	Yes
SB-NX-X310 LH	Yes	.010	3	1 5/8"	Yes	Yes

# NYTRX<sup>®</sup> XV<sup>3</sup>

Part #	Removable Wheel	Pin Size	# of Pins	Sight Housing	Lens Kit (Optional)	Sight Light (Optional)
BL-NX-XV319	No	.019	3	1 3/4"	No	Yes
BL-NX-XV319 LH	No	.019	3	1 3/4"	No	Yes
BL-NX-XV310	No	.010	3	1 3/4"	No	Yes
BL-NX-XV310 LH	No	.010	3	1 3/4"	No	Yes



Part #	Removable Wheel	Pin Size	# of Pins	Sight Housing	Lens Kit (Optional)	Sight Light (Optional)
NX-XV319	No	.019	3	1 3/4"	No	Yes
NX-XV319 LH	No	.019	3	1 3/4"	No	Yes
NX-XV310	No	.010	3	1 3/4"	No	Yes
NX-XV310 LH	No	.010	3	1 3/4"	No	Yes



Part #	Removable Wheel	Pin Size	# of Pins	Sight Housing	Lens Kit (Optional)	Sight Light (Optional)
HYT-NX-XV319	No	.019	3	1 3/4"	No	Yes
HYT-NX-XV319 LH	No	.019	3	1 3/4"	No	Yes
HYT-NX-XV310	No	.010	3	1 3/4"	No	Yes
HYT-NX-XV310 LH	No	.010	3	1 3/4"	No	Yes



Part #	Removable Wheel	Pin Size	# of Pins	Sight Housing	Lens Kit (Optional)	Sight Light (Optional)
SB-NX-XV319	No	.019	3	1 3/4"	No	Yes
SB-NX-XV319 LH	No	.019	3	1 3/4"	No	Yes
SB-NX-XV310	No	.010	3	1 3/4"	No	Yes
SB-NX-XV310 LH	No	.010	3	1 3/4"	No	Yes



# PROVEN BY THE *PROS.*



JEFF ALTHOFF - LOVE THE GRIND



JUSTIN ZARR - BOWHUNT OR DIE

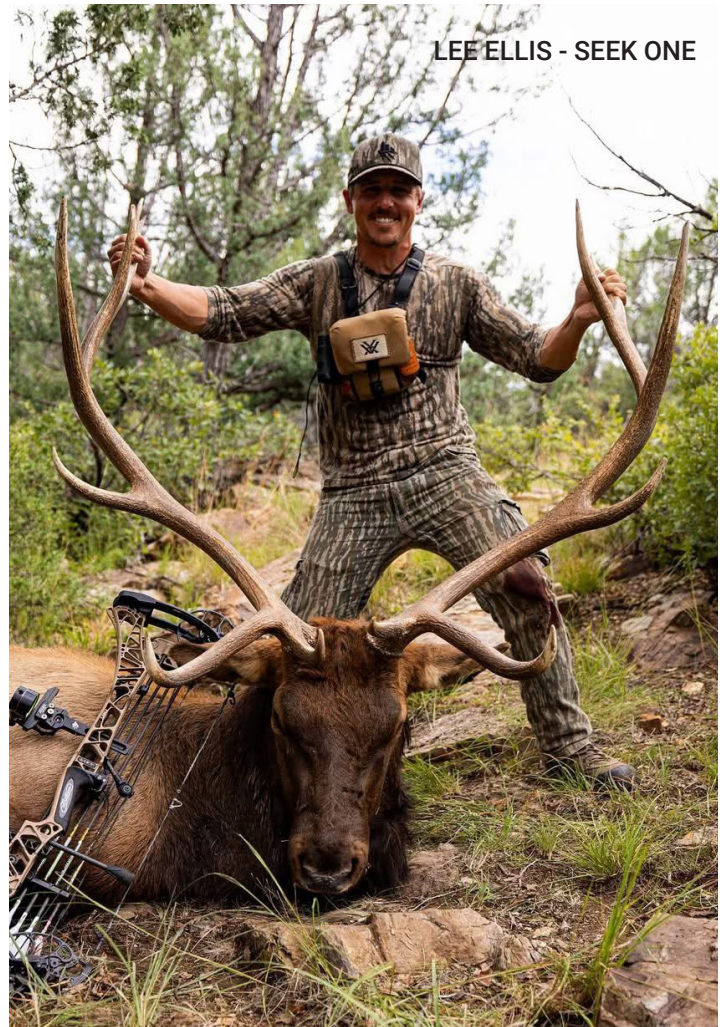

LEE ELLIS - SEEK ONE



NICK VENTURA - ART OF THE WILD



GREGG RITZ - HUNT MASTERS



TODD GRAF - BOWHUNT OR DIE



JJ DUKART - DEER SOCIETY



BRENNEN NADING - THE BREAKING POINT TV



MARTIN CHAGNOVICH

# OPTIMIZER LITE X

Once mounted to the bow, the Optimizer Lite X features tool free windage and elevation adjustments. Complete with the accuracy of our patented R.D.S. sight tape technology in five yard increments, this sight is sure to boost shooter confidence from the back yard to that next trip to the treestand. Available with a choice of .010, .019 or .029 fiber and two housing diameters, you'll find out in a hurry why single pin sights have become so popular. Accepting a full line of accessories including lights, sun shades, and magnified lenses, archers can't go wrong when choosing the new and improved Optimizer Lite X.

Part #	Sight Housing	Pin Size	Mechanical Rheostat	Lens Kit (Optional)	Sight Light (Optional)
LX-5000	1 5/8"	.029	No	Lens Kit B	Yes
LX-5000LH	1 5/8"	.029	No	Lens Kit B	Yes
LX-5019	1 5/8"	.019	No	Lens Kit B	Yes
LX-5019LH	1 5/8"	.019	No	Lens Kit B	Yes
LX-5010	1 5/8"	.010	No	Lens Kit B	Yes
LX-5010LH	1 5/8"	.010	No	Lens Kit B	Yes

Part #	Sight Housing	Pin Size	Mechanical Rheostat	Lens Kit (Optional)	Sight Light (Optional)
LX-5500	1 5/8"	.029	Yes	Lens Kit B	Yes
LX-5500LH	1 5/8"	.029	Yes	Lens Kit B	Yes
LX-5519	1 5/8"	.019	Yes	Lens Kit B	Yes
LX-5519LH	1 5/8"	.019	Yes	Lens Kit B	Yes
LX-5510	1 5/8"	.010	Yes	Lens Kit B	Yes
LX-5510LH	1 5/8"	.010	Yes	Lens Kit B	Yes



# ACCESSORIES

Need a light for hunting in a ground blind or dense cover? Check. Running into issues mounting a quiver? We have a fix for that. Eyes not what they used to be or need a little extra magnification for your spot league? We've got you covered. And speaking of covers, we have those too. Regardless of your individual needs, you can customize your HHA sight to your liking with a wide variety of accessories.

## LYT Rechargeable Sight Light

- 3 Brightness Settings
- Rechargeable
- Compact and Low-Profile Design



## Ultraview/Dark Owl Scope Adapter

The HHA Ultraview/Dark Owl Scope Adapter allows you to adapt your Tetra sight (2020 models and newer) to be compatible with an Ultraview or Dark Owl scope. The UV-MICRO comes with the entire HHA windage system which includes a windage rod specific to any Ultraview or Dark Owl scope, an Infinite Adjust Plate, as well as a T-rail.



## Long Distance Sight Tapes

Compatible with all NYTRX and Tetra sights



## Replacement Indicator Needles for NYTRX™ Sights

Available for  
NDL-X1  
NDL-X2  
NDL-X3  
NDL-X4

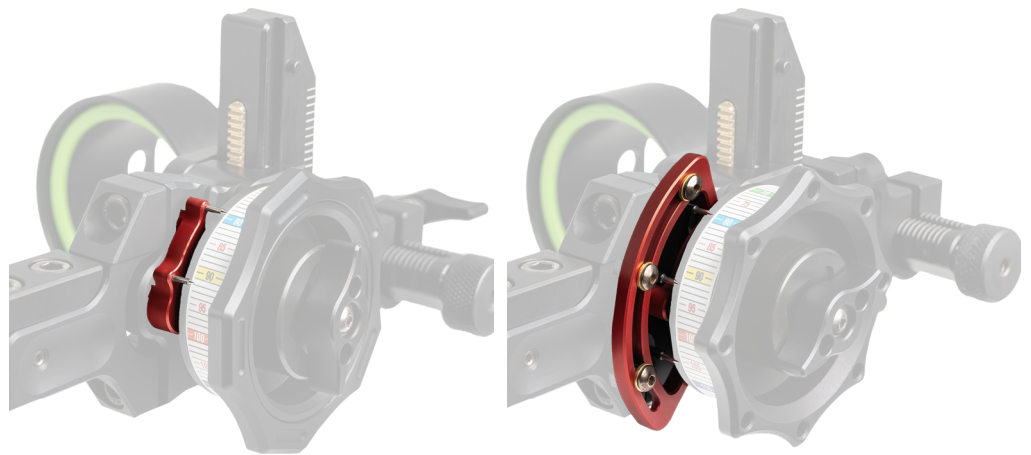

# OL-3019

A top choice for hunters and 3D shooters alike, the Optimizer Lite was the first sight in the HHA product line to feature our patented R.D.S. Sight Tape Technology. 1 5/8" scope housing is available with your choice of a single .019 or .029 pin.

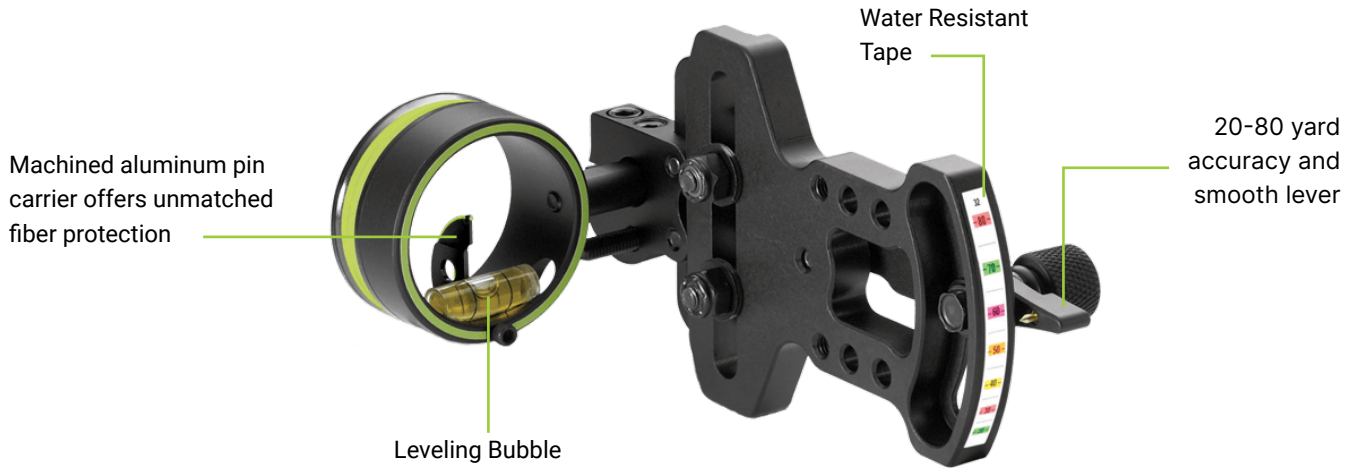

# OL-CD

Compact, light weight design is ideal for youth, beginners and bowfishing.





TREY HEDGECK



CHRIS HAMM



KADEN KREUTZER



CHRIS HOOD



JOHN CASSIMUS



JAKE MANCL



KELBY HAWKINS



DILLON BENNETT



CLAYTON COYLE



DYLAN LUTHER



JONAH BELL



MITCH STAMM



[www.hhasports.com](http://www.hhasports.com)